



DEEP SEA ELECTRONICS PLC

**702 AUTOMATIC START MODULE
OPERATING INSTRUCTIONS**

Author:- Anthony Manton

**Deep Sea Electronics Plc
Highfield House
Hunmanby
North Yorkshire
YO14 0PH
England**

**Tel: +44 (0) 1723 890099
Fax: +44 (0) 1723 893303
email: Sales@Deepseapl.com**



<< This page is intentionally blank >>

TABLE OF CONTENTS

1	DESCRIPTION OF OPERATION	4
1.1	MANUAL MODE OPERATION	4
1.2	AUTOMATIC MODE OF OPERATION	5
1.3	WARNINGS	6
1.4	SHUTDOWNS	6
2	SETTINGS	7
2.1	FIXED SETTINGS	7
2.2	CONFIGURABLE SETTINGS	7
3	TERMINAL DESCRIPTION	7
4	SPECIFICATION	8
5	SOLID STATE OUTPUTS	9
5.1	TYPICAL CONNECTIONS	9
6	DIMENSIONS	10
7	TYPICAL CONNECTIONS	10

1 DESCRIPTION OF OPERATION

1.1 MANUAL MODE OPERATION

To initiate a start sequence in **MANUAL**, turn the key to the  position. To start the set, press the  button. Preheating will begin, indicated by the  LED.

NOTE:- There is no Start Delay in this mode of operation. Starting will commence as soon as the start button is pressed.

The **Fuel Solenoid** is energised, then the **Starter Motor** is engaged.

The engine is cranked for a 10-second period. If the engine fails to fire during this cranking attempt then the starter motor is disengaged for a 10-second period. Should this sequence continue beyond the 3 starting attempts, the start sequence will be terminated and **Fail to Start**  fault will be illuminated.

When the engine fires, the starter motor is disengaged and locked out at 20 Hz measured from the Alternator output.

After the starter motor has disengaged, the **Safety On** timer is activated (which is fixed at 10 seconds), allowing Oil Pressure, High Engine Temperature, Under-speed and Charge Fail to stabilise without triggering the fault.

Selecting **STOP**  de-energises the **FUEL SOLENOID**, bringing the generator to a stop.

1.2 AUTOMATIC MODE OF OPERATION

To initiate a start sequence in **AUTO**, turn the key to the  position. The start sequence is initiated when the remote start input is activated.

After a fixed 5 second start delay, Preheating will occur (fixed at 10s) , indicated by the  LED. the **Fuel Solenoid** is energised, then one second later, the **Starter Motor** is engaged.

The engine is cranked for a 10-second period. If the engine fails to fire during this cranking attempt then the starter motor is disengaged for a 10-second rest period. Should this sequence continue beyond the 3 starting attempts, the start sequence will be terminated and

Fail to Start  fault will be illuminated.

When the engine fires, the starter motor is disengaged and locked out at 20 Hz measured from the Alternator output..

After the starter motor has disengaged, the **Safety On** timer is activated, allowing Oil Pressure, High Engine Temperature, Under-speed and Charge Fail to stabilise without triggering the fault.

On removal of the **Remote Start** signal the **Stop** delay timer is initiated. Once this timer has expired the **Fuel Solenoid** is de-energised, bringing the generator to a stop.

1.3 WARNINGS

Warnings are used to warn the operator of an impending fault

BATTERY CHARGE FAILURE, if the module does not detect a voltage from the warning light terminal on the auxiliary charge alternator, the  icon will illuminate.

1.4 SHUTDOWNS

Shutdowns are latching and stop the Generator. The alarm must be cleared, and the fault removed to reset the module. In the event of a shutdown the appropriate LED will be illuminated

NOTE:- The alarm condition must be rectified before a reset will take place. If the alarm condition remains it will not be possible to reset the unit (The exception to this is the Low Oil Pressure alarm and similar 'delayed alarms', as the oil pressure will be low with the engine at rest).

FAIL TO START, if the engine does not fire after the pre-set 3 attempts at starting, a shutdown will be initiated.

The  icon will illuminate.

LOW OIL PRESSURE, if the module detects that the engine oil pressure has fallen below the low oil pressure switch after the **Safety On** timer has expired, a shutdown will occur.

The  icon will illuminate.

HIGH ENGINE TEMPERATURE if the module detects that the engine coolant temperature has exceeded the high engine temperature switch after the **Safety On** timer has expired, a shutdown will occur.

The  icon will illuminate.

OVERSPEED, if the engine speed exceeds the pre-set trip (14% above the nominal frequency) a shutdown is initiated. Overspeed is not delayed, it is an **immediate shutdown**.

The  icon will illuminate.

NOTE:- During the start-up sequence the overspeed trip level is extended to 24% above the normal frequency for the duration of the safety timer to allow an extra trip level margin. This is used to prevent nuisance tripping on start-up.

UNDERSPEED, if the engine speed falls below 20Hz (fixed) after the **Safety On** timer has expired, a shutdown is initiated.

The  icon will flash.

NOTE:- The  icon is used to indicate both underspeed and overspeed. A flashing  icon indicates underspeed. A steady  icon indicates overspeed.

2 SETTINGS

2.1 FIXED SETTINGS

The following settings are factory set and are NOT adjustable.

Crank disconnect	20Hz
Underspeed	20Hz
Overspeed	57Hz (50Hz nominal) 68 Hz (60Hz nominal)
Remote start delay	5s
Preheat	10s
Crank period	10s
Crank rest	10s
Safety delay	10s
Remote stop delay	30s

2.2 CONFIGURABLE SETTINGS

The following setting is factory set to 50Hz but is user adjustable.

To select between 50/60Hz nominal frequency, operate the selector switch into the correct position as shown opposite.

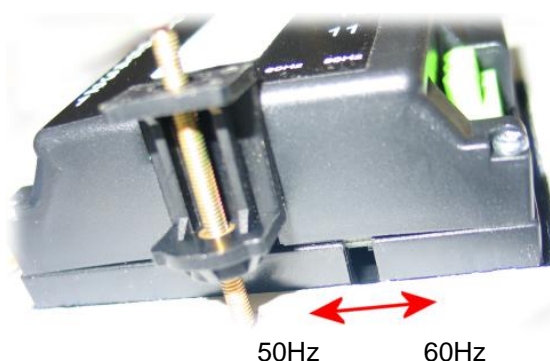

3 TERMINAL DESCRIPTION

PIN No	DESCRIPTION	CABLE SIZE	NOTES
1	DC Plant Supply Input (-ve)	1.0mm	Connected to plant battery negative
2	DC Plant Supply Input (+ve)	1.0mm	Connected to plant battery positive (Recommended Fuse 2A)
3	Fuel relay Output	0.5mm	Used to operate the fuel solenoid control relay.
4	Start relay Output	0.5mm	Used to operate the cranking control relay.
5	Preheat Output relay	0.5mm	Used to operate the preheat control relay.
6	Remote Start Input	0.5mm	Switch to negative to start set.
7	Charge Fail Input/ Excitation Output	1.0mm	Must NOT be connected to plant supply negative if not used.
8	Low Oil Pressure Input	0.5mm	Switch to negative on fault.
9	High Engine Temp Input	0.5mm	Switch to negative on fault.
10	Alternator Input L1	1.0mm	2A Fuse
11	Alternator Input N	1.0mm	

NOTE:- All the outputs are solid state, rated at 1.2 Amps 8 Volts to 35 Volts DC, and switch to battery negative when active.

4 SPECIFICATION

DC Supply:	8 Volts to 35 Volts DC Continuous.
Cranking Dropouts:	Able to survive 0 Volts for 50 mS, providing supply was at least 10 V before dropout and supply recovers to 5 Volts. This is achieved without the need for internal batteries.
Max. Current:	Operating 50mA Standby 10mA
Alternator Input Range:	15 Volts (ph-N) to 277 Volts (ph-N) AC (+20%)
Alternator Input Frequency:	50 - 60 Hz at rated engine speed (Minimum: 75V AC Ph-N) (Crank Disconnect from 15V Ph-N @ 20Hz) Overspeed +14% (+24% overshoot)
Start Output:	1.2 Amp DC at supply voltage.
Fuel Output:	1.2 Amp DC at supply voltage.
Preheat Output:	1.2 Amp DC at supply voltage.
Dimensions:	84mm x 72mm x 34.9mm (3.3" x 2.8" x 1.4")
Operating Temperature Range:	-30°C to + 70°C
Applicable Standards	Compliant with BS EN 60950 Low Voltage Directive Compliant with BS EN 50081-2: 1992 EMC Directive Compliant with BS EN 61000-6-4: 2000 EMC Directive  Compliance to European Legislation



Registered Component for USA & Canada

Deep Sea Electronics plc reserve the right to change specification without notice.

5 SOLID STATE OUTPUTS

DSE's utilisation of Solid State Outputs gives many advantages, the main points being:

- ◆ No Moving Parts
- ◆ Fully Overload / Short Circuit Protected.
- ◆ Smaller dimensions hence lighter, thinner and cheaper than conventional relays.
- ◆ Less power required making them far more reliable.

The main difference from conventional outputs is that solid state outputs switch to negative (-ve) when active. This type of output is normally used with an automotive or plug in relay.

5.1 TYPICAL CONNECTIONS

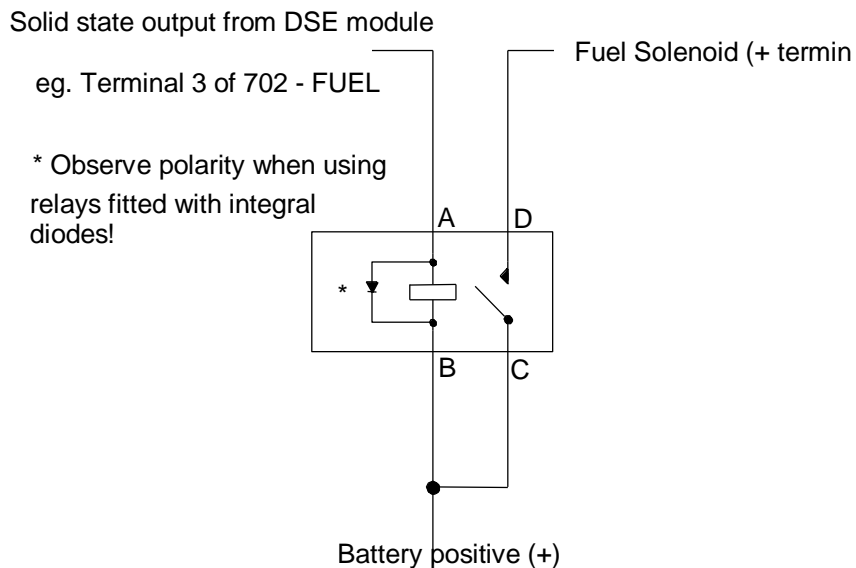

	Solid State Output from DSE Module Pin	Automotive relay Pin	8 Pin Plugin relay	Function
A	3	86	7	Fuel Output
B		85	2	To Positive supply via fuse
C		30	1	To Positive supply via fuse
D		87	3	To Fuel Solenoid

Example of relay pins connected to DSE solid state output to drive a fuel solenoid.
See section on **Typical Connections** else where in this manual for overall typical wiring diagram

6 DIMENSIONS

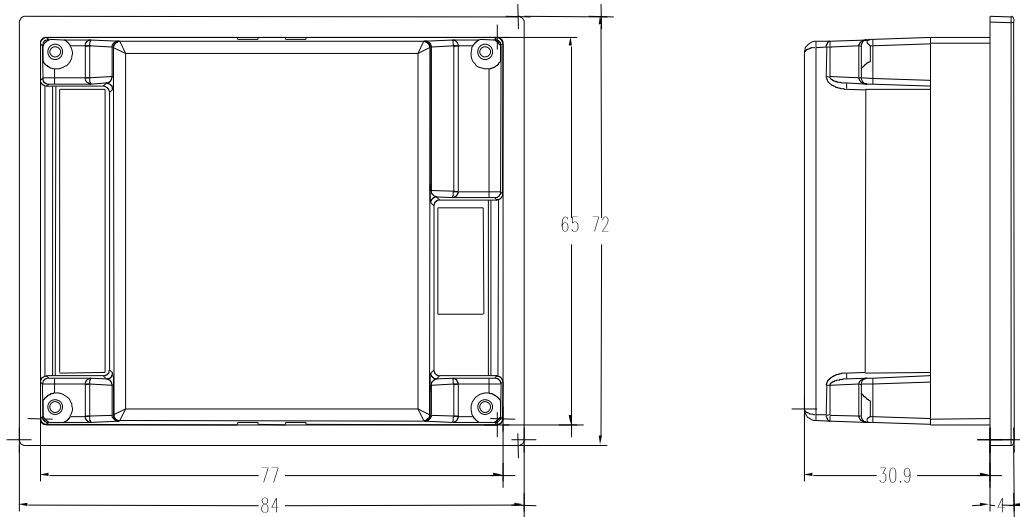

Imperial measurements

Overall dimensions (excluding key)

3.3" x 2.8" x 1.4"

(protrudes 0.16" out of panel)

7 TYPICAL CONNECTIONS

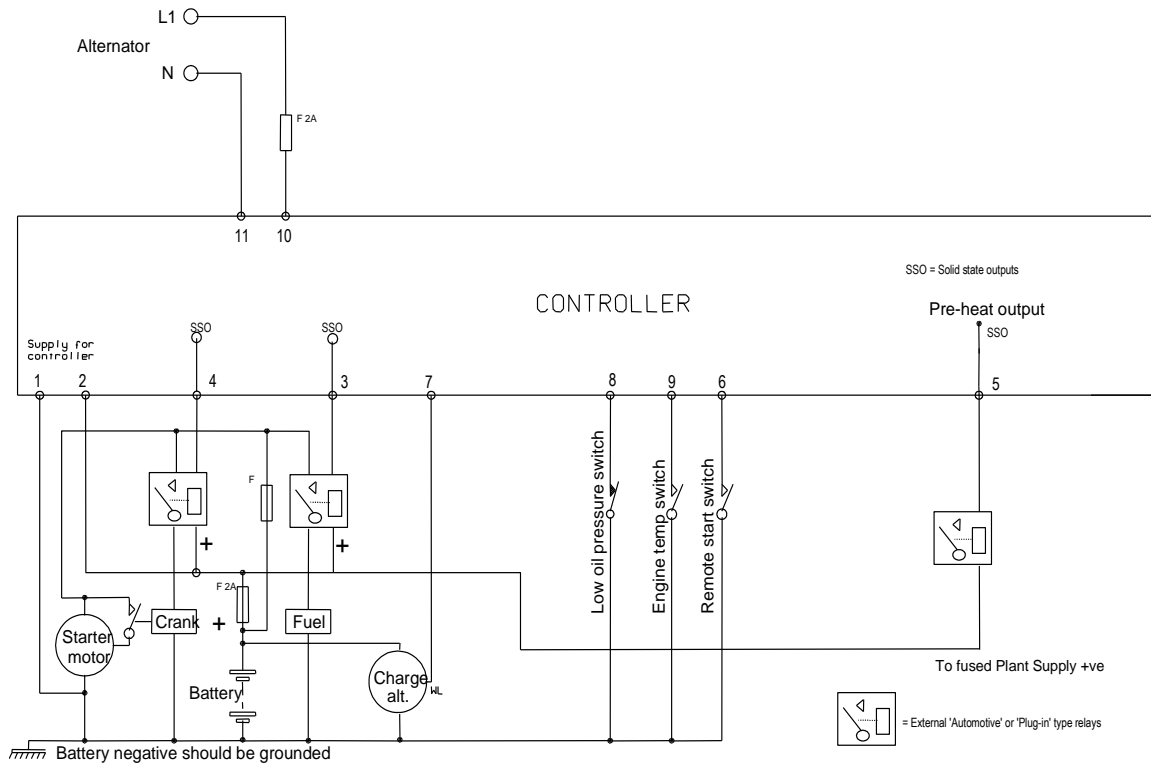

Terminals suitable for 22-16 awg (0.6mm²-1.3mm²) field wiring
Tightening Torque = 0.8N-m (7lb-in)



DEEP SEA ELECTRONICS PLC

**701 KEY START MODULE
OPERATING INSTRUCTIONS**

Author:- John Ruddock

**Deep Sea Electronics Plc
Highfield House
Hunmanby
North Yorkshire
YO14 0PH
England**

**Tel: +44 (0) 1723 890099
Fax: +44 (0) 1723 893303
email: Sales@Deepseapl.com**

<< This page is intentionally blank >>

TABLE OF CONTENTS

1 DESCRIPTION OF OPERATION	4
1.1 WARNINGS	5
1.2 SHUTDOWNS	5
2 CONFIGURATION INSTRUCTIONS.....	6
3 TERMINAL DESCRIPTION.....	7
4 SPECIFICATION	8
5 SOLID STATE OUTPUTS	9
6 DIMENSIONS	10
7 TYPICAL CONNECTIONS.....	10

1 DESCRIPTION OF OPERATION

To start the generator turn the key switch to the hand position,  which will power up the unit.

If at this time the auxiliary input is active the  led will be illuminated, preventing the start of the generator.

Pressing the **pre-heat**  button will energise the **pre-heat** output. Releasing the button will de-energise the output.





Pressing the **start**  button will energise the **Fuel Solenoid** output, then the **Starter Motor** output. The button should be pressed for the duration of the crank period.



When the engine fires, the starter motor is disengaged and locked out at 20 Hz measured from the Alternator output.

After the starter motor has disengaged, the **Safety On** timer is activated (which is fixed at 12 seconds), allowing Oil Pressure, High Engine Temperature and Charge Fail to stabilise without triggering the fault.

Turning the key to **STOP**  de-energises the **FUEL SOLENOID**, bringing the generator to a stop.

 **NOTE: - The safety on time (used for delayed alarms) is pre set to 12 seconds and can not be changed.**

 **NOTE: - If the generator has not started when the start  button has been released or the generator fails once it is running, the key switch must be turned to STOP  and then back to  before another start can be invoked.**

 **NOTE: - If pre-heat is required during cranking, the pre-heat  button should be pressed at the same time as the start  button.**

 **NOTE: - The 701HC start button is represented by **

1.1 WARNINGS

Warnings are used to warn the operator of an impending fault

BATTERY CHARGE FAILURE, if the module does not detect a voltage from the warning light terminal on the auxiliary charge alternator, the  icon will illuminate.

1.2 SHUTDOWNS

Shutdowns are latching and stop the Generator. The alarm must be cleared, and the fault removed to reset the module. In the event of a shutdown the appropriate icon will be illuminated

Auxiliary Input, if the auxiliary input is energised an immediate shutdown will occur. The  icon will illuminate.

NOTE: - If the Auxiliary input is used to shutdown the engine, the fault must be cleared before the unit can be reset and the generator restarted.

LOW OIL PRESSURE, if the module detects that the engine oil pressure has fallen below the low oil pressure switch setting, after the **Safety On** timer has expired, a shutdown will occur. The  icon will illuminate.

HIGH ENGINE TEMPERATURE if the module detects that the engine coolant temperature has exceeded the high engine temperature switch setting, after the **Safety On** timer has expired, a shutdown will occur. The  icon will illuminate.

OVERSPEED, if the engine speed exceeds the pre-set trip (14% above the nominal frequency) a shutdown is initiated. Overspeed is not delayed, it is an **immediate shutdown**. The  icon will illuminate.

NOTE: - During the start-up sequence the overspeed trip level is extended to 24% above the normal frequency for the duration of the safety timer to allow an extra trip level margin. This is used to prevent nuisance tripping on start-up.

NOTE: - The safety on time (used for delayed alarms) is pre set to 12 seconds and can not be changed.

2 CONFIGURATION INSTRUCTIONS

- ◆ The only parameter to be configured is the nominal frequency, either 50 Hz or 60 Hz. The change is made via a switch which is accessible through a slot in the base of the module, (see photo)

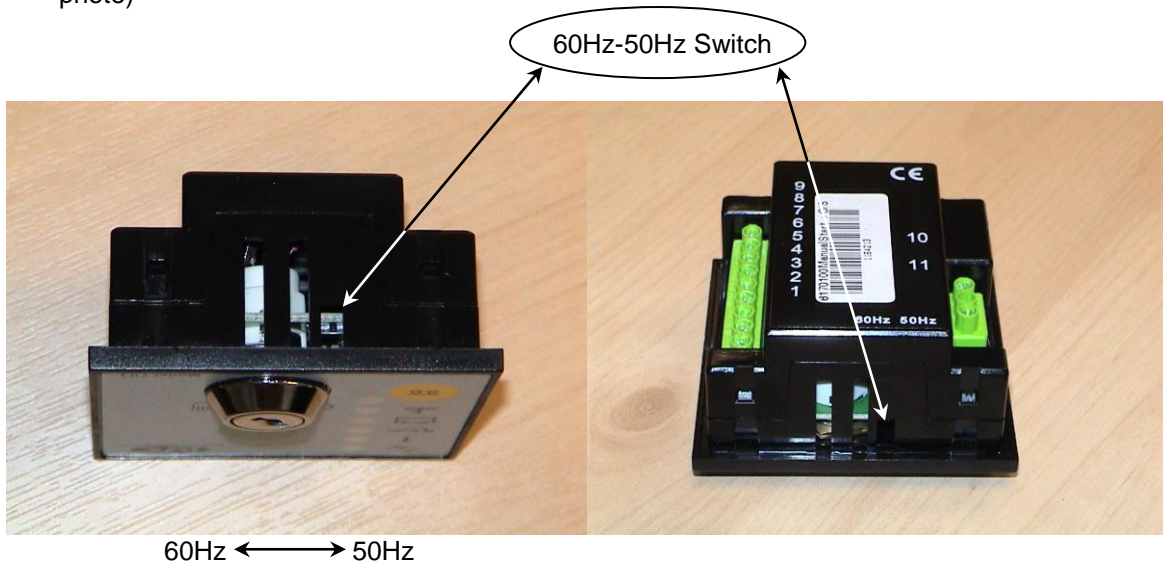

- ◆ This switch adjusts the over speed trip from 57 Hz to 68 Hz, and over shoot from 62 Hz to 70 Hz.



Model 701



Model 701 HC

3 TERMINAL DESCRIPTION

PIN No	DESCRIPTION	CABLE SIZE	NOTES
1	DC Plant Supply Input (-ve)	1.0mm	Connected to plant battery negative
2	DC Plant Supply Input (+ve)	1.0mm	Connected to plant battery positive (Recommended Fuse 2A)
3	Fuel relay Output	1.0mm	Used to operate the fuel relay.
4	Start relay Output	1.0mm	Used to operate the cranking relay.
5	Pre-Heat Output	1.0mm	Used to operate the pre heaters. E.g. glow plugs
6	Auxiliary Input Shutdown	1.0mm	Switch to negative.
7	Charge Fail Input/ Excitation Output	1.0mm	Must NOT be connected to plant supply negative if not used.
8	Low Oil Pressure Input	0.5mm	Switch to negative.
9	High Engine Temp Input	0.5mm	Switch to negative.
10	Alternator Input N	1.0mm	Connect to Generator Neutral (AC).
11	Alternator Input L1	1.0mm	Connect to Generator L1 supply (AC) (Recommend 2A Fuse Max.)

NOTE:- All the outputs are solid state, rated at 1.2 Amps 8 Volts to 35 Volts DC, and switch to battery negative when active.

4 SPECIFICATION

DC Supply:	8 Volts to 35 Volts DC Continuous.
Cranking Dropouts:	Able to survive 0 Volts for 50 mS, providing supply was at least 10 V before dropout and supply recovers to 5 Volts. This is achieved without the need for internal batteries.
Max. Current:	Operating 9mA In Off Mode 0mA
Hours Counter (701 HC only)	0 – 99,999.9 Hours. Tamper Proof
Alternator Input Range:	15 Volts (ph-N) to 305 Volts (ph-N) AC (+20%)
Alternator Input Frequency:	50 - 60 Hz at rated engine speed (Minimum: 75V AC Ph-N) (Crank Disconnect from 15V Ph-N @ 20Hz) Overspeed +14% (+24% overshoot)
Start Output:	1.2 Amp DC at supply voltage.
Fuel Output:	1.2 Amp DC at supply voltage.
Pre Heat:	1.2 Amp DC at supply voltage.
Charge Fail:	3 Volts
Operating Temperature Range:	-30°C to + 70°C
Applicable Standards	Compliant with BS EN 60950 Low Voltage Directive Compliant with BS EN 50081-2: 1992 EMC Directive Compliant with BS EN 61000-6-4: 2000 EMC Directive  Compliance to European Legislation



Registered Component for USA & Canada

Deep Sea Electronics plc reserve the right to change specification without notice.

5 SOLID STATE OUTPUTS

DSE's utilisation of Solid State Outputs gives many advantages, the main points being:

- ◆ No Moving Parts
- ◆ Fully Overload / Short Circuit Protected.
- ◆ Smaller dimensions hence lighter, thinner and cheaper than conventional relays.
- ◆ Less power required making them far more reliable.

The main difference from conventional outputs is that solid state outputs switch to negative (-ve) when active. This type of output is normally used with an automotive or plug in relay.

TYPICAL CONNECTIONS

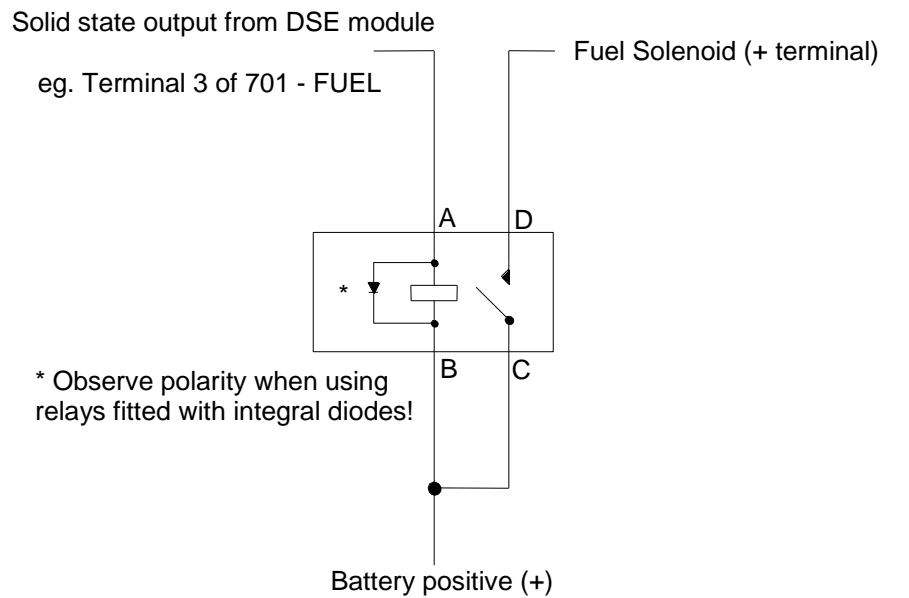

	Solid State Output from DSE Module Pin	Automotive relay Pin	8 Pin Plugin relay	Function
A	3	86	7	Fuel Output
B		85	2	To Positive supply via fuse
C		30	1	To Positive supply via fuse
D		87	3	To Fuel Solenoid

Example of relay pins connected to DSE solid state output to drive a fuel solenoid.
See overleaf for overall typical wiring diagram

6 DIMENSIONS

701

Dimensions: Excluding Key

72mm x 72mm x 38mm
(2.83" x 2.83" x 1.32")

Panel cutout:

68mm x 68mm
(2.68" x 2.68")

Mounting Method:

2 x Fixing Clips (Supplied).

701HC

Dimensions: Excluding Key

84mm x 72mm x 34.9mm
(3.3" x 2.8" x 1.4")

Panel cutout:

80mm x 68mm
(3.14" x 2.67")

Mounting Method:

2 x Fixing Clips (Supplied).

7 TYPICAL CONNECTIONS

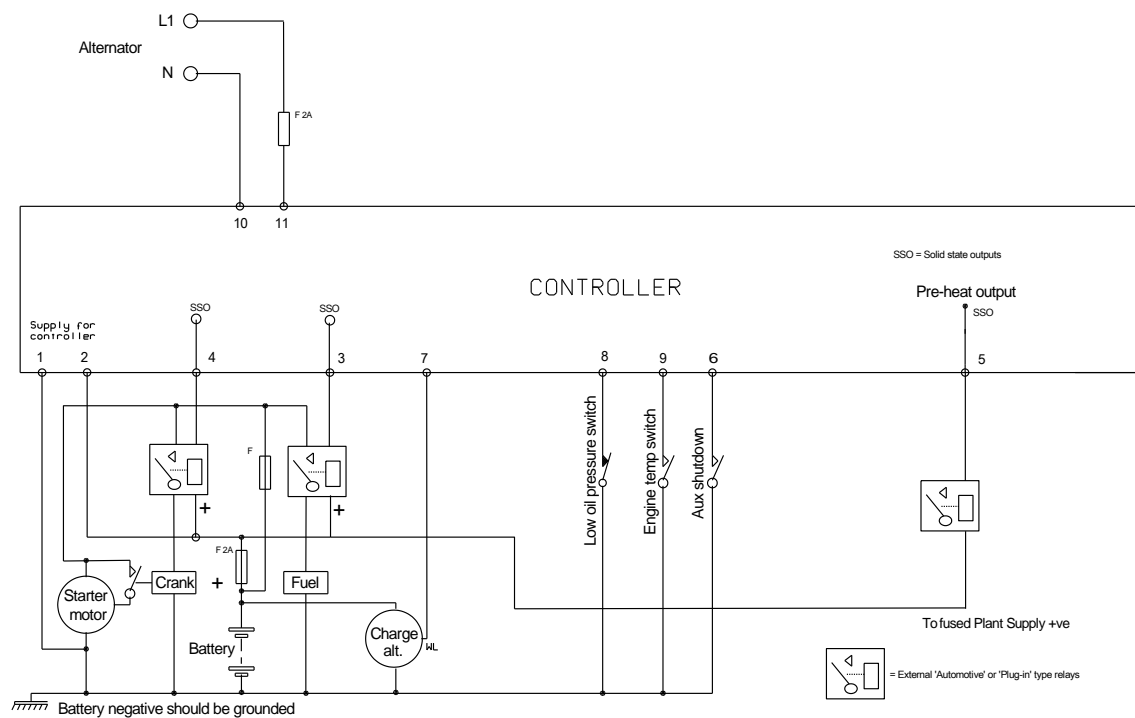

Terminals suitable for 22-16 awg (0.6mm²-1.3mm²) field wiring
Tightening Torque = 0.8N-m (7lb-in)

<< This page is intentionally blank >>